

Tower Crane
Grue à tour

Turmdrehkran

35 K

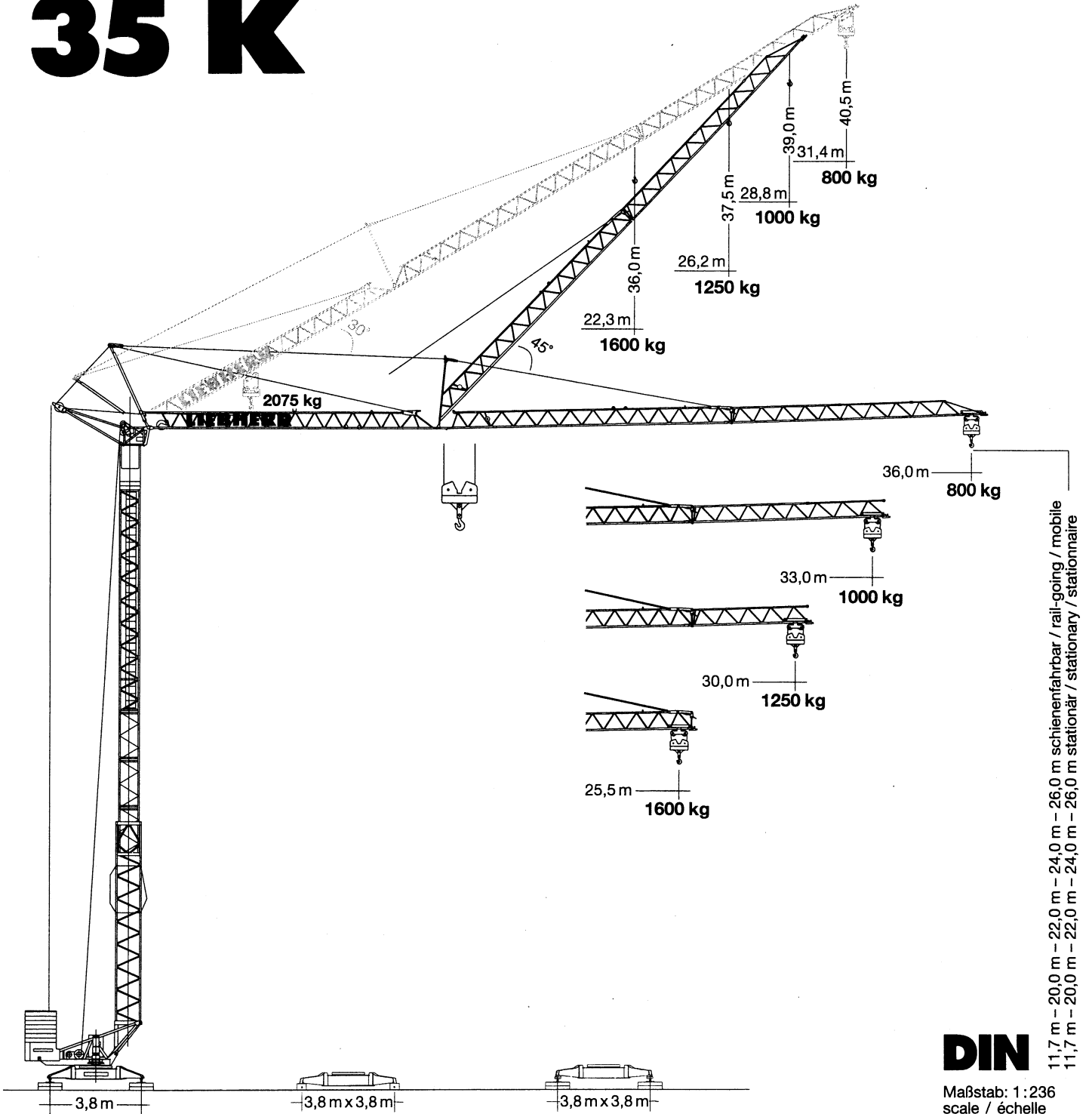

11,7 m - 20,0 m - 22,0 m - 24,0 m - 26,0 m schienenfahbar / rail-going / mobile
11,7 m - 20,0 m - 22,0 m - 24,0 m - 26,0 m stationär / stationary / stationnaire

DIN

Maßstab: 1 : 236
scale / échelle

LIEBHERR

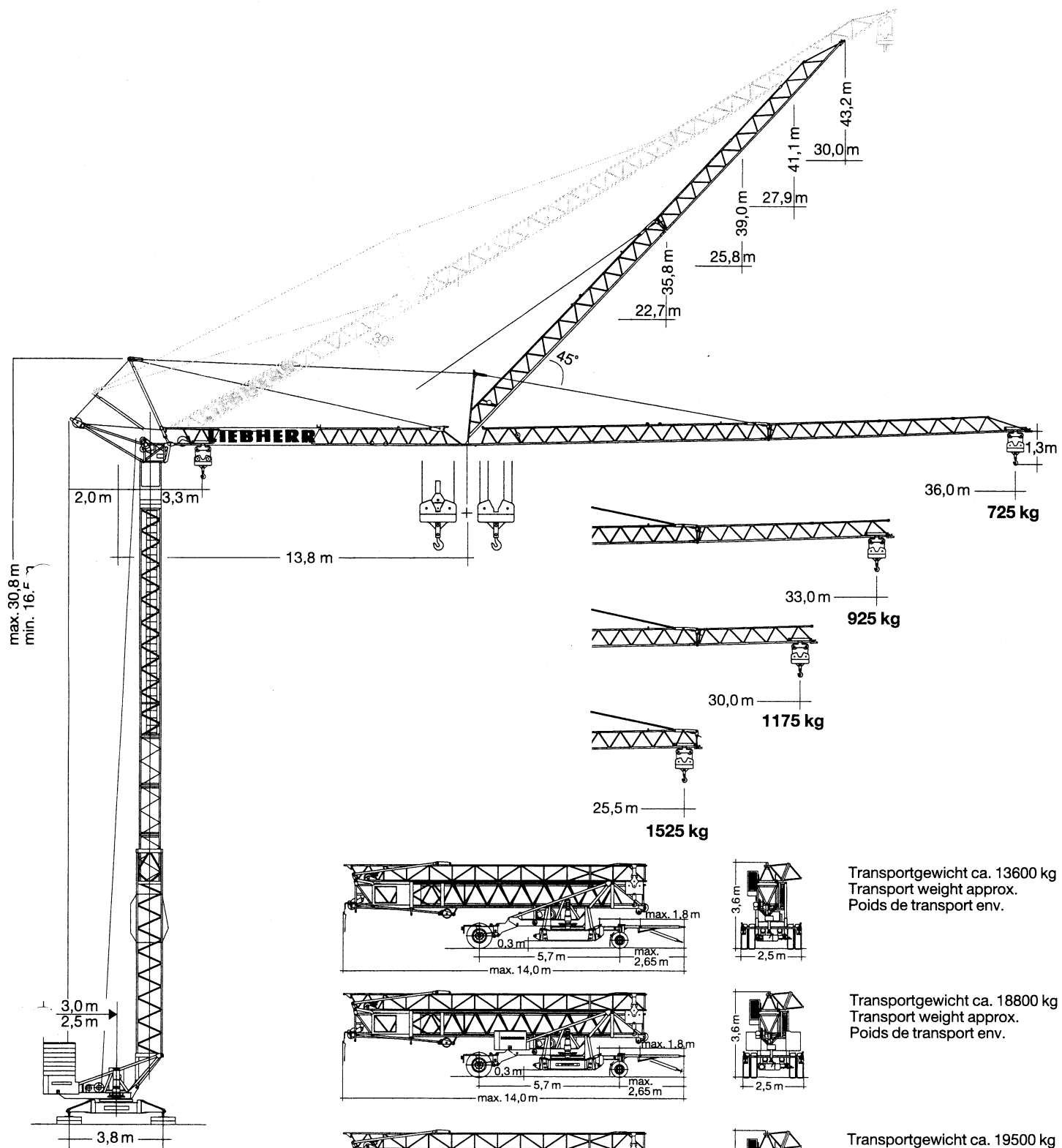

Gewicht

Weight

Poids

Zentralballast Central ballast weight Lest de base		1400 kg	Konstruktionsgewicht ca. Dead weight approx. Poids de la construction env.	10160 kg (bei max. HH 26 m: + 900 kg)
Gegengewicht Counterweight Contrepoids	r = 3,0 m r = 2,5 m	19960 kg 23670 kg		

35 K

Ausladung und Tragfähigkeit

Radius and capacity / Portée et charge

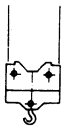
Auslegerlänge Length of jib Longueur de flèche m	max. kg m/kg		m/kg																					
			16,0	17,0	18,0	19,0	20,0	21,0	22,0	23,0	24,0	25,0	25,5	26,0	27,0	28,0	29,0	30,0	31,0	32,0	33,0	34,0	35,0	36,0
36,0	3,3-16,7 2075		2075	2040	1900	1780	1670	1570	1490	1410	1330	1270	1250	1210	1150	1100	1050	1010	970	930	890	860	830	800
33,0	3,3-18,2 2075		2075	2075	2075	1970	1850	1740	1650	1560	1480	1410	1375	1340	1280	1230	1170	1130	1080	1040	1000			
30,0	3,3-19,7 2075		2075	2075	2075	2075	2040	1930	1820	1730	1640	1560	1520	1490	1420	1360	1300	1250						
25,5	3,3-20,5 2075		2075	2075	2075	2075	2075	2020	1910	1810	1720	1640	1600											

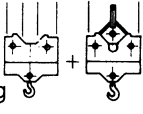
m	max. kg m/kg		m/kg																					
			10,0	11,0	12,0	13,0	14,0	16,0	18,0	20,0	22,0	24,0	25,5	26,0	27,0	28,0	29,0	30,0	31,0	32,0	33,0	34,0	35,0	36,0
36,0	3,3-9,8 4000	-16,7 2000	3890	3430	3070	2770	2520	2120	1830	1600	1410	1260	1175	1130	1080	1030	980	930	890	860	820	790	750	725
33,0	3,3-10,5 4000	-18,2 2000	4000	3790	3390	3060	2790	2350	2030	1780	1570	1410	1300	1270	1210	1150	1100	1050	1010	960	925			
30,0	3,3-11,3 4000	-19,7 2000	4000	4000	3730	3370	3070	2600	2240	1970	1750	1560	1450	1410	1350	1280	1230	1175						
25,5	3,3-11,8 4000	-20,5 2000	4000	4000	3910	3540	3220	2730	2360	2070	1840	1650	1525											

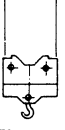
m	max. kg m/kg		Auslegersteilstellung 30° Elevated jib 30° Flèche inclinée 30° m/kg																				
			14,0	15,0	16,0	17,0	18,0	19,0	20,0	21,0	22,3	23,0	24,0	25,0	26,2	27,0	28,0	28,8	30,0	31,0	31,4		
36,0	3,1-14,7 2075		2075	2030	1875	1740	1620	1510	1420	1340	1240	1190	1130	1070	1010	970	930	895	850	810	800		
33,0	3,1-16,0 2075		2075	2075	2075	1925	1790	1680	1570	1480	1380	1330	1260	1190	1130	1080	1040	1000					
30,0	3,1-17,3 2075		2075	2075	2075	2075	1980	1850	1740	1640	1520	1470	1390	1320	1250								
25,5	3,1-18,0 2075		2075	2075	2075	2075	2075	1940	1830	1720	1600												

Geschwindigkeiten

Speeds / Vitesses

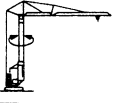
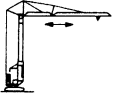
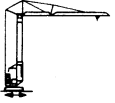
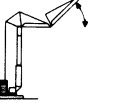
	U/min 0-1,0 sl./min tr./min	2,2 kW
	20,0 / 40,0 m/min	1,3 / 2,3 kW
	25,0 m/min	2 x 1,3 kW
	0-45° ca. 30 sec.	4,0 kW

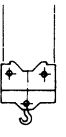
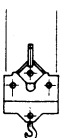
Hubwerk Hoist unit Mécanisme de levage	Stufe Step Cran	kg	m/min
11,0 kW 	1	2075	6,0
	2	2075	25,0
	3	1000	50,0
11,0 kW 	1	2000 4000	6,0 3,0
	2	2000 4000	25,0 12,5
	3	1000 2000	50,0 25,0

Leitungsquerschnitt bei 380 V bis 63,0 m 4 x 10 mm²
Cross section of cable up to
Section de câble à jusqu'à

Betriebsspannung 380 V
Operating voltage
Tension de service

Frequenz 50 Hz
Frequency
Fréquence

Anschlußwert 21,0 kVA
Power requirement
Puissance requise

Technische Kenngröße nach BGL
Technical nominal size according to the construction machinery list (BGL)
Grandeur caractéristique suivant le barème d'emploi des appareils (BGL)

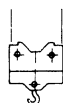

2108-0035

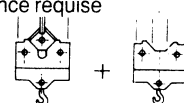

2108-0035

Technische Daten - Technical data

Caractéristiques techniques

Aufstellvorgang

Erection procedure

Déroulement de montage

Ballastierausladung 5,0 m
 Ballasting radius 5,0 m
 Portée pour dispositif de lestage 5,0 m

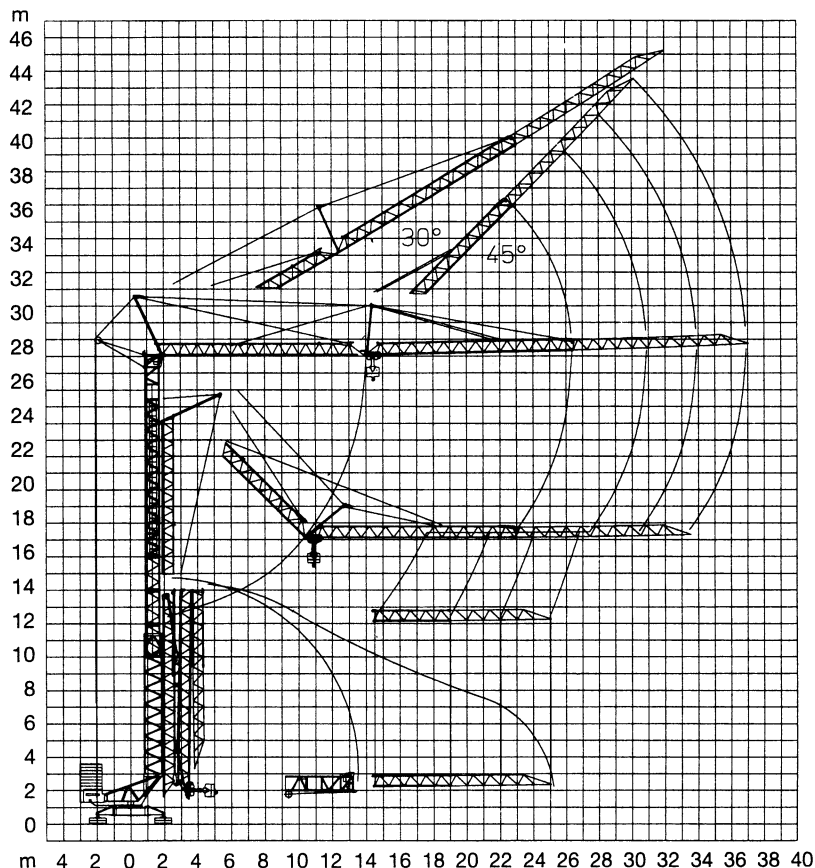

Kolli-Liste

Packing List

Liste de colisage

Pos. Item Rep.	Anz. Qty. Qté	Turmstück Tower section Élément de mât			L (m)	B (m)	H (m)	kg
1	3				2,10	0,85	0,88	350
2	1	Ausleger-Verlängerung 25,5 m – 30,0 m Jib extension Rallonge de la flèche			4,70	0,80	0,70	175
3	1	Ausleger-Verlängerung 30,0 m – 33,0 m Jib extension Rallonge de la flèche			3,10	0,80	0,70	100
4	1	Ausleger-Verlängerung 33,0 m – 36,0 m Jib extension Rallonge de la flèche			3,10	0,80	0,70	70
5	1	Transportachse vorne Tra 50 KW 1 Road transport axle front Essieux de transport avant			3,10	1,42	0,98	465
6	1	Transportachse vorne Tra 100 KY 1 Road transport axle front Essieux de transport avant			3,00	1,13	0,97	660
7	1	Transportachse hinten Tra 120 GY 1 Road transport axle behind Essieux de transport arrière			1,90	2,50	1,05	1150
8	1	Transportachse Tra 200 GZ 3 Road transport axle Essieux de transport			3,10	2,50	1,10	2600
9	1	Kiste mit Seilen und Kleinteilen Case with ropes and small parts Caisse avec câbles et pièces détachées			1,00	0,80	1,00	450

Datenblatt Nr. 120 P – 2870 H 1 B 3 DIN 15018 • BGL 2108-0035 und OENORM T 3 • 04.94

Data sheet

Feuille de caractéristiques

Konstruktionsänderungen vorbehalten!

Subject to alterations!

Sous réserves de modifications!

Printed in Germany

Nehmen Sie Kontakt auf mit
 Contact

Mettez-vous en rapport avec

LIEBHERR-WERK BIBERACH GMBH, Postfach 1663, D-88396 Biberach an der Riß

☎ (07351) 41-0, Fax (07351) 41225, Tx 71802